



**GROVE<sup>®</sup>**  
**CRANE**

A GROVE WORLDWIDE COMPANY



**CUSTOM SERVICE CRANE, INC.**

# GMK5175

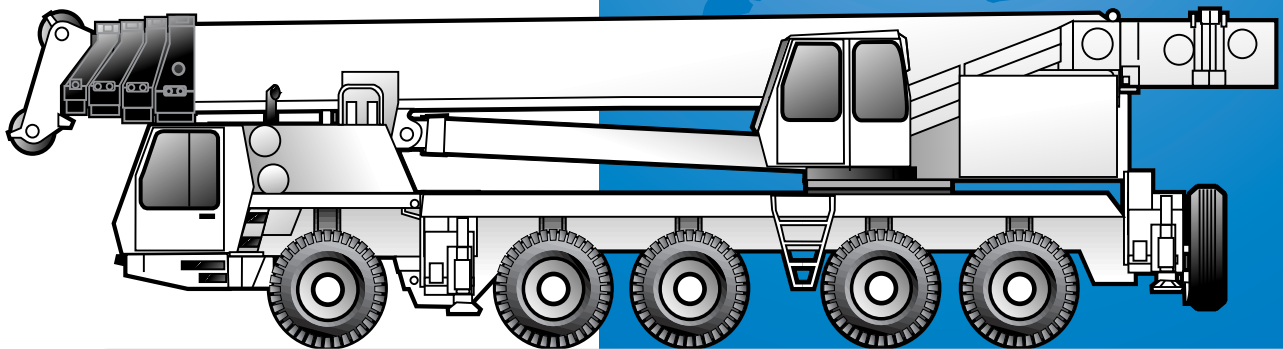

**All Terrain Hydraulic Crane**



**CUSTOM SERVICE CRANE, INC.**

[www.CustomServiceCrane.com](http://www.CustomServiceCrane.com) | t: 217-897-1700 | [Randy@customservicecrane.com](mailto:Randy@customservicecrane.com)

# Dimensions

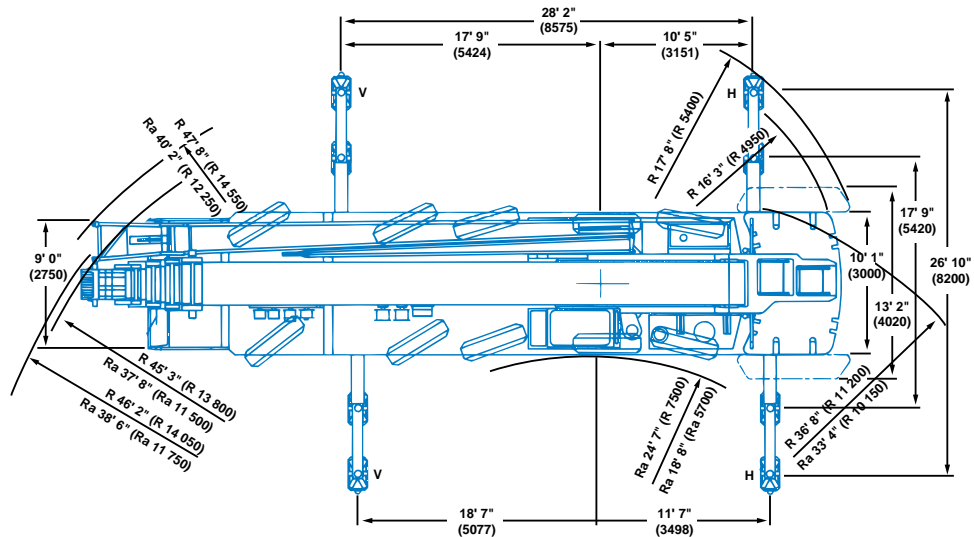

Ra, ra = Radius all wheels steered

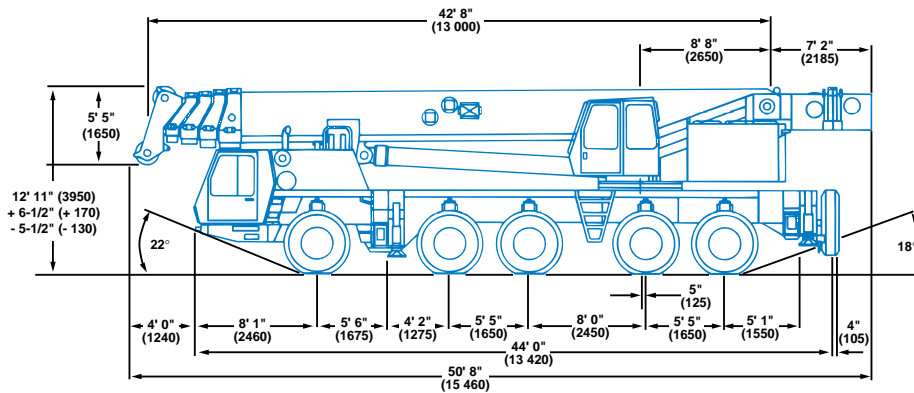

Note: ( ) Reference dimensions in mm

## Model GMK 5175 equipped with:

10 x 8 x 10 Drive/Steer 20.5 R25 Tires,  
Hydraulic Oil Cooler, Main & Auxiliary Hoists  
with cable. (LESS all counterweight, hook  
block, outrigger floats and lattice extension).  
NOTE: Auxiliary hoist is fixed installation/  
non-removable.

	3 x Front Axles	2 x Rear Axles	Total
	78,940 lbs.	54,290 lbs.	133,230 lbs.
	(3 x 26,313)	(2 x 27,145)	

## Weights for accessory equipment:

1. Outrigger Floats Stowed	+ 140	+ 260	+ 400
2. Brackets for Lattice Ext. to Stow on Base Boom	+ 490	- 50	+ 440
3. Lattice Ext. -33 ft.	+ 4,600	- 1,180	+ 3,420
4. Lattice Ext. -33/59 ft.	+ 5,380	- 970	+ 4,410
5. 10 x 6 x 10 Drive Steer in lieu of standard	- 135	- 735	- 870
6. 16.00 R25 Tires in lieu of 14.00 R25	+ 790	+ 530	+ 1,320
7. 14.00 R25 Tires in lieu of 20.5 R25	- 1,340	- 890	- 2,230
8. Bracket for Spare Tire	- 30	+ 85	+ 55
9. Spare Tire - 14.00R25	- 300	+ 830	+ 530
10. Spare Tire - 16.00R25	- 370	+ 1,030	+ 660
11. Spare Tire - 20.5R25	- 420	+ 1,170	+ 750
12. Non Supply of Auxiliary Hoist	+ 1,280	- 3,280	- 2,000
13. Remove Rear Outrigger Beams/Jacks	+ 2,395	- 7,795	- 5,400
14. Remove Front Outrigger Beams/Jacks	- 5,165	+ 705	- 4,460
15. Hook block 50 ton carrier	+ 960	+ 530	+ 1,490

# Working Range



43 - 161 ft.  
(13.0 - 49.0 m)



33 - 141 ft.  
(10.0 - 43.0 m)

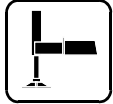

360°

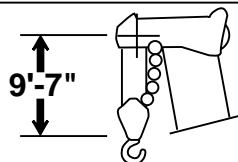
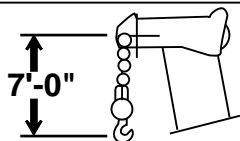
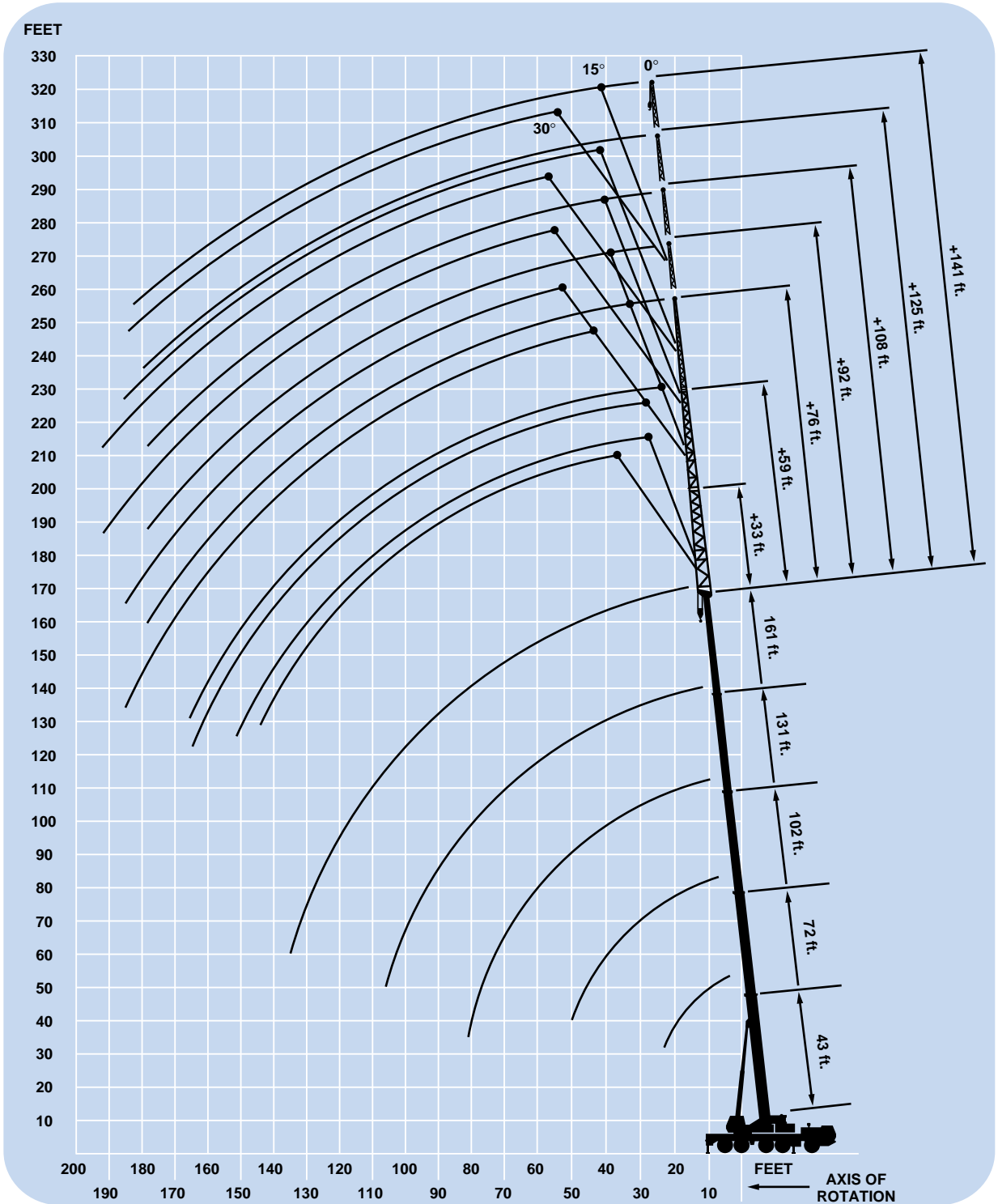

**DIMENSIONS ARE FOR LARGEST GROVE FURNISHED HOOK BLOCK AND HEADACHE BALL, WITH ANTI-TWO BLOCK ACTIVATED.**

# Superstructure specifications

## Boom

43 ft. to 161 ft. (13.0 m to 49.0 m) five-section full power boom.

Maximum tip height: 171 ft. (52 m).

## Lattice Extension

33 ft. to 59 ft. (10.0 m to 18.0 m) lattice swingaway extension offsettable at 0°, 15° and 30°.

Maximum tip height: 230 ft. (70 m).

## \*Optional Lattice Jib Extension

Five 16 ft. (5.0 m) inserts for use with lattice swingaway extension to increase length up to 141 ft. (43.0 m). 0°, 15° and 30° offset.

## Boom Elevation

Single cylinder with integral holding valve provides elevation from -1.5° to 85°.

## Load Moment & Anti-Two Block System

Load moment and anti-two block system with audio-visual warning and control lever lock-out. These systems provide electronic display of boom angle, length, radius, tip height, relative load moment, maximum permissible load, load indication and warning of impending two-block condition.

## Cab

Full vision aluminum cab, safety glass windows, hinged windscreen with windshield wiper, door with sliding windows, sun visor and roller blind, engine hot water heating, fan and defroster nozzle.

Adjustable operator's seat with hydraulic suspension, armrest integrated crane controls and neck support. Ergonomically arranged instrumentation and operating controls for crane and engine.

## Swing

Axial piston motor with planetary gear and holding brake. Swing speed variable from 0 - 1.5 RPM.

## Counterweight

99,200 lbs. (45 000 kg) total, split into seven sections for separate transportation. Hydraulically installed and removed.

## Engine

Mercedes Benz OM 366 A diesel, 6 cylinders, water-cooled, 139 hp (104 kW) @ 1800 RPM. Maximum torque: 413 ft. lbs. at 1500 to 1600 RPM.

## \*Optional Engine

Cummins 6 BTA 5.9-C diesel, 6 cylinders, water-cooled, 168 hp (125 kW) @ 2000 RPM. Maximum torque: 483 ft. lbs. at 1600 RPM.

## Fuel Tank Capacity

52.8 gallons (200 L).

## Hydraulic System

Three separate circuits with 2 axial piston variable displacement pumps in open circuit with electronic engine speed related pump control and 2 gear pumps for slewing. Thermostatically controlled oil cooler.

396 gallon (1500 L) reservoir capacity.

All crane movements are infinitely variable through armrest-mounted multi-directional joystick control levers that return to neutral when released.

## Electrical System

Two batteries 12 V/170 Ah each. Generator: 28 V/55 A.

## HOIST SPECIFICATIONS

### Main Hoist

Axial piston motor with planetary gear and automatic multiple disk brake. Rope drum with special grooving, and special wire rope.

Single line pull: 15,400 lbs.  
(70 kN)

Single line speed: 394 FPM  
(120 m/min)

Rope diameter: 19 mm

Rope length: 984 ft.  
(300 m)

### Auxiliary Hoist

Axial piston motor with planetary gear and automatic multiple disk brake. Rope drum with special grooving, and special wire rope.

Single line pull: 15,400 lbs.  
(70 kN)

Single line speed: 394 FPM  
(120 m/min)

Rope diameter: 19 mm

Rope length: 787 ft.  
(240 m)

*\*Denotes optional equipment.*

# Carrier specifications

## Chassis

Five-axle, all-welded torsion-resistant box-type construction of high strength steel.

## Outriggers

Four hydraulically telescoping beam outriggers with vertical cylinders and outrigger pads. Independent horizontal and vertical movement control on each side of chassis. Crane level indicators at each control station.

## Engine

Mercedes Benz OM 442 LA diesel, 8 cylinders, water-cooled, with turbocharger and supercharger intercooler, 503 hp (370 kW) @ 2100 RPM. Maximum torque: 1,475 ft. lbs. at 1100 to 1600 RPM.

## \*Optional Engine

Cummins N525 E20 diesel, 6 cylinders, water-cooled, with turbocharger and supercharger intercooler, 518 hp (386 kW) @ 2100 RPM. Maximum torque: 1,843 ft. lbs. at 1200 to 1400 RPM.

## Fuel Tank Capacity

105 gallons (400 L).

## Transmission

Allison automatic powershift transmission with 5 forward and 1 reverse gears. Two speed Kessler transfer case with longitudinal differential lock.

## Drive/Steer

10 x 8 x 10

## Axles

1st axle line - steer.  
2nd axle line - drive/steer.  
3rd axle line - drive/steer.  
4th axle line - steer (off road only)/drive.  
5th axle line - drive/steer.  
Drive axles with planetary hub reduction and center mounted gearing.

## Suspension

Exclusive "MEGATRAK™" independent hydropneumatic suspension and hydraulic axle lock-out. Level regulation. Suspension range: +6.7 in. (170 mm) to -5.1 in. (-130 mm). Automatic suspension level control.

## Tires

10 - 20.5R25 radials.

## Steering

Dual circuit hydraulic power-assisted steering. Automatic switch-in of standby steering pump in case of main pump failure.

## Brakes

Service brake: pneumatic dual circuit acting on all wheels. Air dryer. Parking brake: pneumatically operated spring-loaded brake acting on 2nd, 3rd, 4th and 5th axle lines. Auxiliary brake: hydraulic retarder integrated with automatic transmission.

## Cab

Aluminum, two-man design, safety glass, laminated front windshield, windshield wiper/washer, driver's seat with hydraulic suspension, engine hot water heater, defroster nozzle, lockable doors with sliding windows, heated rearview mirrors. Complete instrumentation and driving controls. Stereo radio/cassette. Cab can be tilted forward by 60° for easy access to engine, transmission, hydraulic pumps, heater and batteries.

## Electrical System

24 V lighting system and signals.  
Generator: 28 V/55 A.  
Two batteries: 12 V/170 Ah each.

## Maximum Speed

Mercedes Engine - 20.5R25 Tires: 46 mph (74 km/h)  
\*Cummins Engine - 20.5R25 Tires: 55 mph (89 km/h)

## Gradeability (Theoretical)

Mercedes Engine - 20.5R25 Tires: 50%  
\*Cummins Engine - 20.5R25 Tires: 52.9%

## Gross Vehicle Weight (approximate)

133,230 lbs. (60 433 kg) see page 2.

## Miscellaneous Standard Equipment

Hydraulic oil cooler; spare tire and wheel - 20.5R25 with carry bracket; spare parts/service manuals; flashing amber warning light on carrier cab; working light; tool kit, wheel chocks, fire extinguisher; rooster sheave.

## Special Equipment to Dismantle Crane for Travel

Boom float kit for boom dolly operation including electric and air line plugs at rear of carrier frame (less dolly).  
Hydraulic quick disconnect fittings for removal of outrigger beams and jacks.  
Hydraulic quick disconnect fittings for removal of complete boom.

## Optional Equipment

\* 10 x 6 x 10 drive  
\* Hookblocks and headache balls  
\* 14.00R25 tires  
\* 16.00R25 tires

*\*Denotes optional equipment*



43 - 161 ft.  
(13.0 - 49.0 m)



99,200 lbs.  
(45 000 kg)



100%



360°



Pounds

(Feet)	43*	43	57	72	87	102	131	146	161
10	350,000**	268,000	155,000	194,000	155,000	110,000			
15	278,000	232,000	155,000	190,000	155,000	110,000	80,000		
20	226,000	189,000	144,000	164,000	145,000	110,000	80,000	61,000	46,000
25	185,000	159,000	124,000	141,000	127,000	110,000	80,000	61,000	46,000
30	137,000	136,000	108,000	123,000	111,000	100,000	80,000	61,000	46,000
35			96,000	108,000	97,000	89,000	76,000	59,000	46,000
40			85,000	96,000	86,000	78,000	70,000	55,000	46,000
45			77,000	81,000	77,000	70,000	64,000	52,000	46,000
50				71,000	68,000	63,000	58,000	49,000	46,000
55				62,000	58,000	57,000	53,000	46,000	43,200
60					50,000	51,000	49,000	43,600	40,400
65					42,800	44,000	45,000	41,400	37,800
70					37,000	38,200	41,400	39,200	35,800
75					32,200	33,200	37,800	36,800	33,800
80						29,000	33,600	34,600	31,600
85						25,400	30,000	30,800	30,000
90						21,000	26,800	27,600	28,400
95							23,800	24,800	26,400
100							21,400	22,200	24,000
105							19,600	20,000	21,600
110							18,600	18,000	19,600
115							17,600	16,200	17,800
120							16,800	14,400	16,000
125								13,000	14,600
130								11,600	13,200
135									11,800
140									10,600
145									9,600

\*  28' 2" X 26' 10"/17' 9" ± 90° over rear.

Lifting capacities greater than 269,000 lbs. require additional heavy lift equipment.

\*\*Only ± 0° over rear.

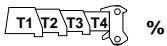

	T1	T2	T3	T4	%
T1	0	0	0	100/0/0	100
T2	0	0	50	0/100/0	50
T3	0	0	0	0/0/50	0
T4	0	0	0	0/0/50	0

NOTE: All main boom charts available with 50% outriggers.



43 - 161 ft.  
(13.0 - 49.0 m)



66,100 lbs.  
(30 000 kg)



100%



360°



Pounds

(Feet)	43*	43	57	72	87	102	131	146	161
10	337,000	268,000	155,000	194,000	155,000	110,000			
15	276,000	228,000	155,000	190,000	155,000	110,000	80,000		
20	220,000	186,000	144,000	164,000	145,000	110,000	80,000	61,000	46,000
25	148,000	157,000	124,000	141,000	127,000	110,000	80,000	61,000	46,000
30	103,000	132,000	108,000	123,000	111,000	100,000	80,000	61,000	46,000
35			96,000	96,000	97,000	89,000	76,000	59,000	46,000
40			81,000	81,000	76,000	78,000	70,000	55,000	46,000
45			67,000	67,000	62,000	63,000	64,000	52,000	46,000
50				56,000	51,000	52,000	57,000	49,000	46,000
55				47,000	42,400	43,600	49,000	46,000	43,200
60					35,400	36,600	41,600	42,600	40,400
65					29,800	31,000	35,800	36,800	37,800
70					25,200	26,800	31,000	32,000	33,800
75					21,200	25,200	28,600	28,000	29,600
80						23,600	26,400	24,400	26,200
85						22,200	24,800	21,400	23,200
90						21,000	23,400	18,800	20,400
95							21,400	16,400	18,200
100							19,200	14,400	16,000
105							17,400	12,600	14,200
110							15,600	11,000	12,600
115							14,200	9,400	11,000
120							12,800	8,000	9,600
125								6,800	8,400
130								5,600	7,200
135									6,200
140									5,200
145									4,400

\*  28' 2" X 26' 10"/17' 9" ± 90° over rear.

Lifting capacities greater than 269,000 lbs. require additional heavy lift equipment.

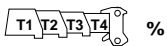

	T1	T2	T3	T4	%
T1	0	0	0	100/0/0	100
T2	0	0	50	0/100/0	50
T3	0	0	0	0/0/50	0
T4	0	0	0	0/0/50	0

NOTE: All main boom charts available with 50% outriggers.



43 - 161 ft.  
(13.0 - 49.0 m)



44,100 lbs.  
(20 000 kg)



100%



360°



Pounds

(Feet)	43	57	72	87	102	131	146	161
10	268,000	155,000	194,000	155,000	110,000			
15	226,000	155,000	190,000	155,000	110,000	80,000		
20	184,000	144,000	164,000	145,000	110,000	80,000	61,000	46,000
25	150,000	124,000	141,000	127,000	110,000	80,000	61,000	46,000
30		108,000	107,000	105,000	100,000	80,000	61,000	46,000
35		85,000	85,000	80,000	81,000	76,000	59,000	46,000
40		67,000	67,000	62,000	63,000	67,000	55,000	46,000
45		54,000	54,000	49,000	51,000	56,000	52,000	46,000
50			45,000	39,800	41,000	46,000	47,000	46,000
55			37,200	32,400	33,600	38,800	39,800	41,800
60				26,600	31,000	35,600	33,800	35,600
65				21,800	28,600	32,800	28,800	30,600
70				17,600	26,800	29,800	24,600	26,400
75					25,200	26,200	21,000	22,800
80					23,600	23,200	18,000	19,800
85					22,200	20,400	15,400	17,200
90					20,400	18,200	13,000	14,800
95						16,000	11,000	12,800
100						14,200	9,200	11,000
105						12,400	7,600	9,200
110						11,000	6,200	7,800
115						9,600	4,800	6,600
120						8,400		5,400



T1	T2	T3	T4	%
T1	0	0	100/0/0	100
T2	0	50	0/100/0	50
T3	0	0	0/0/50	0
T4	0	0	0/0/50	0

NOTE: All main boom charts available with 50% outriggers.





43 - 161 ft.  
(13.0 - 49.0 m)



24,300 lbs.  
(11 000 kg)



100%



360°



Pounds

(Feet)	43	57	72	87	102	131	146	161
10	268,000	155,000	194,000	155,000	110,000			
15	224,000	155,000	190,000	155,000	110,000	80,000		
20	179,000	144,000	164,000	145,000	110,000	80,000	61,000	46,000
25	130,000	124,000	122,000	111,000	107,000	80,000	61,000	46,000
30		90,000	90,000	81,000	79,000	80,000	61,000	46,000
35		67,000	67,000	62,000	62,000	64,000	59,000	46,000
40		52,000	52,000	47,000	48,000	51,000	51,000	46,000
45		41,400	41,400	36,200	39,600	45,000	42,000	43,000
50			37,600	27,800	36,400	41,600	34,800	36,000
55			34,400	21,400	33,600	35,200	29,000	30,200
60				16,400	31,000	29,800	24,000	25,600
65				12,200	27,600	25,200	19,600	21,600
70				9,000	24,000	21,600	16,200	18,000
75					20,800	18,400	13,200	15,000
80					18,200	15,800	10,600	12,400
85					16,000	13,600	8,400	10,200
90					14,000	11,600	6,600	8,400
95						10,000		6,600
100						8,400		
105						7,200		
110						6,000		



%

T1	0	0	100/0/0	100	100/0	100/0	100	100
T2	0	50	0/100/0	50	100/0	100/100	100	100
T3	0	0	0/0/50	0	0/100	50/100	75	100
T4	0	0	0/0/50	0	0/100	50/100	75	100

NOTE: All main boom charts available with 50% outriggers.



43 - 161 ft.  
(13.0 - 49.0 m)



13,200 lbs.  
(6000 kg)



100%



360°



Pounds

(Feet)	43	57	72	87	102	131	146	161
10	268,000	155,000	194,000	155,000	110,000			
15	222,000	155,000	190,000	155,000	110,000	80,000		
20	167,000	144,000	143,000	135,000	110,000	80,000	61,000	46,000
25	111,000	111,000	106,000	93,000	89,000	80,000	61,000	46,000
30		76,000	76,000	67,000	65,000	67,000	61,000	46,000
35		56,000	56,000	49,000	49,000	51,000	51,000	46,000
40		42,400	45,000	36,600	43,600	49,000	40,400	41,400
45		32,200	41,000	26,800	39,600	41,000	32,400	33,600
50			33,200	19,600	36,400	34,000	26,200	27,600
55			27,200	14,200	30,600	28,000	21,200	22,600
60				9,800	25,800	23,200	17,200	18,800
65				6,400	21,800	19,400	13,800	15,400
70					18,600	16,200	10,800	12,600
75					16,000	13,600	8,200	10,000
80					13,800	11,400		8,000
85					11,800	9,400		
90					10,000	7,800		
95						6,200		

T1 T2 T3 T4 %

T1	0	0	100/0/0	100	100/0	100/0	100	100
T2	0	50	0/100/0	50	100/0	100/100	100	100
T3	0	0	0/0/50	0	0/100	50/100	75	100
T4	0	0	0/0/50	0	0/100	50/100	75	100

NOTE: All main boom charts available with 50% outriggers.



43 - 161 ft.  
(13.0 - 49.0 m)



0 lbs.  
(0 kg)



100%



360°



Pounds

(Feet)	43	57	72	87	102	131	146	161
10	268,000	155,000	194,000	155,000	110,000			
15	218,000	155,000	190,000	155,000	110,000	80,000		
20	156,000	143,000	132,000	113,000	108,000	80,000	61,000	46,000
25	94,000	95,000	90,000	76,000	73,000	74,000	61,000	46,000
30		64,000	63,000	52,000	50,000	53,000	53,000	46,000
35		45,000	50,000	36,600	49,000	49,000	40,000	40,800
40		32,400	41,800	26,200	43,600	39,800	30,800	32,000
45		23,800	32,800	18,400	36,400	32,400	24,000	25,400
50			26,000	12,400	29,600	26,600	18,800	20,200
55			21,000	7,800	24,200	21,800	14,400	16,000
60					20,200	17,600	11,000	12,600
65					16,800	14,400	8,200	9,800
70					14,000	11,600		7,400
75					11,800	9,400		
80					9,800	7,400		
85					8,000			
90					6,600			

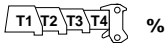

%

T1	0	0	100/0/0	100	100/0	100/0	100	100
T2	0	50	0/100/0	50	100/0	100/100	100	100
T3	0	0	0/0/50	0	0/100	50/100	75	100
T4	0	0	0/0/50	0	0/100	50/100	75	100

NOTE: All main boom charts available with 50% outriggers.



161 ft.  
(49.0 m)



33 - 59 ft.  
(10.0 - 18.0 m)  
FOLDING



99,200 lbs.  
(45 000 kg)



100%



360°



Pounds

(Feet)	33 FEET			59 FEET		
	0°	15°	30°	0°	15°	30°
20	26,600					
25	26,600					
30	26,600			17,000		
35	26,600	26,600		17,000		
40	26,600	26,600	26,600	17,000		
45	26,600	26,400	26,600	17,000	18,000	
50	26,400	26,200	25,800	17,000	18,000	
55	26,000	25,800	24,800	17,000	18,000	
60	25,800	25,400	23,800	17,000	18,000	17,600
65	25,400	24,400	23,000	17,000	18,000	17,000
70	25,000	23,600	22,200	17,000	17,800	16,200
75	24,400	22,600	21,400	17,000	17,200	15,600
80	23,600	21,800	20,600	17,000	16,600	14,800
85	22,600	21,000	20,000	17,000	15,800	14,200
90	21,600	20,200	19,200	17,000	15,200	13,800
95	20,600	19,400	18,600	16,400	14,400	13,400
100	19,600	18,800	18,000	15,600	13,800	13,000
105	18,800	18,200	17,600	15,000	13,400	12,600
110	18,000	17,400	17,000	14,200	12,800	12,200
115	17,200	16,800	16,600	13,400	12,400	11,800
120	16,400	16,000	15,800	13,000	12,000	11,400
125	15,400	15,200	15,200	12,600	11,800	11,200
130	14,200	14,400	14,400	12,200	11,400	10,800
135	12,800	13,400	13,800	11,800	11,000	10,600
140	11,600	12,200	12,400	11,400	10,800	10,400
145	10,400	11,000	11,200	11,000	10,400	10,200
150	9,400	9,800	10,000	10,600	10,200	9,800
155	8,400	8,800	9,000	9,800	9,800	9,600
160	7,600	7,800	8,000	9,000	9,600	9,400
165	6,800	7,000	7,000	8,200	8,800	9,200
170	6,000	6,200	6,200	7,400	8,000	8,400
175	5,200	5,400	5,400	6,600	7,200	7,600
180				5,800	6,400	6,800
185				5,200	5,600	6,000
190				4,600	5,000	5,200
195				4,000	4,400	4,400
200				3,400	3,600	3,600

THIS CHART IS ONLY A GUIDE AND SHOULD NOT BE USED TO OPERATE THE CRANE. The individual crane's load chart, operating instructions and other instructional plates must be read and understood prior to operating the crane.



161 ft.  
(49.0 m)



33 - 59 ft.  
(10.0 - 18.0 m)  
FOLDING



66,100 lbs.  
(30 000 kg)



100%



360°



Pounds

(Feet)	33 FEET			59 FEET		
	0°	15°	30°	0°	15°	30°
20	26,600					
25	26,600					
30	26,600			17,000		
35	26,600	26,600		17,000		
40	26,600	26,600	26,600	17,000		
45	26,600	26,400	26,600	17,000	18,000	
50	26,400	26,200	25,800	17,000	18,000	
55	26,000	25,800	24,800	17,000	18,000	
60	25,800	25,400	23,800	17,000	18,000	17,600
65	25,400	24,400	23,000	17,000	18,000	17,000
70	25,000	23,600	22,200	17,000	17,800	16,200
75	24,400	22,600	21,400	17,000	17,200	15,600
80	23,600	21,800	20,600	17,000	16,600	14,800
85	22,600	21,000	20,000	17,000	15,800	14,200
90	21,600	20,200	19,200	17,000	15,200	13,800
95	19,400	19,400	18,600	16,400	14,400	13,400
100	17,200	18,200	18,000	15,600	13,800	13,000
105	15,400	16,200	17,000	15,000	13,400	12,600
110	13,600	14,400	15,200	14,200	12,800	12,200
115	12,000	12,800	13,400	13,400	12,400	11,800
120	10,600	11,400	12,000	12,200	12,000	11,400
125	9,400	10,000	10,600	10,800	11,800	11,200
130	8,200	8,800	9,400	9,600	11,000	10,800
135	7,200	7,800	8,200	8,600	9,800	10,600
140	6,200	6,600	7,000	7,600	8,800	9,600
145	5,200	5,800	6,000	6,600	7,800	8,600
150	4,400	4,800	5,000	5,800	6,800	7,600
155	3,600	4,000	4,200	5,000	6,000	6,600
160	2,800	3,200	3,400	4,200	5,000	5,600
165	2,200	2,400	2,600	3,600	4,400	4,800
170				3,000	3,600	4,000
175				2,400		

THIS CHART IS ONLY A GUIDE AND SHOULD NOT BE USED TO OPERATE THE CRANE. The individual crane's load chart, operating instructions and other instructional plates must be read and understood prior to operating the crane.



131 ft.  
(40.0 m)



76 - 92 - 108 - 125 - 141 ft.  
(23 - 28 - 33 - 38 - 43 m)



99,200 lbs.  
(45 000 kg)



100%



360°



Pounds

(Feet)	76 FEET			92 FEET			108 FEET			125 FEET			141 FEET		
	0°	15°	30°	0°	15°	30°	0°	15°	30°	0°	15°	30°	0°	15°	30°
15															
20	12,800			11,200											
25	12,800			11,200											
30	12,800			11,200			9,400								
35	12,800			11,200			9,400			7,600			5,600		
40	12,800			11,200			9,400			7,600			5,600		
45	12,800	12,400		11,200			9,400			7,600			5,600		
50	12,800	12,200		11,200	10,800		9,400	9,000		7,600			5,600		
55	12,800	12,000		11,200	10,400		9,400	8,600		7,600	7,200		5,600		
60	12,800	11,600	10,400	11,200	9,800		9,200	8,200		7,600	7,200		5,600	6,000	
65	12,800	11,400	10,200	10,600	9,400		8,800	7,800		7,600	7,200		5,600	6,000	
70	12,200	11,200	10,000	10,000	9,200	8,800	8,400	7,600	7,400	7,600	7,200		5,600	6,000	
75	11,800	10,800	9,800	9,600	8,800	8,600	8,000	7,400	7,200	7,600	7,200		5,600	6,000	
80	11,200	10,600	9,600	9,200	8,600	8,400	7,600	7,000	7,000	7,400	7,000	6,800	5,600	6,000	6,400
85	10,800	10,200	9,400	8,800	8,400	8,200	7,400	6,800	6,800	7,000	6,800	6,600	5,600	6,000	6,400
90	10,600	10,000	9,200	8,600	8,200	8,200	7,200	6,800	6,600	7,000	6,600	6,400	5,600	6,000	6,400
95	10,200	9,800	9,000	8,400	8,000	8,000	6,800	6,600	6,600	6,800	6,600	6,200	5,600	6,000	6,200
100	10,000	9,800	9,000	8,000	7,800	8,000	6,600	6,400	6,400	6,600	6,400	6,000	5,600	6,000	6,000
105	9,800	9,600	8,800	7,800	7,600	7,800	6,600	6,200	6,400	6,400	6,000	5,800	5,600	6,000	6,000
110	9,600	9,400	8,600	7,800	7,600	7,800	6,400	6,200	6,400	6,200	6,000	5,600	5,600	5,800	5,800
115	9,400	9,400	8,600	7,600	7,400	7,800	6,200	6,000	6,200	6,000	5,800	5,400	5,400	5,400	5,600
120	9,400	9,200	8,400	7,400	7,400	7,800	6,200	6,000	6,200	5,800	5,600	5,400	5,000	5,200	5,200
125	9,200	9,000	8,400	7,400	7,400	7,800	6,000	6,000	6,200	5,600	5,400	5,400	4,800	4,800	5,000
130	9,200	8,800	8,200	7,200	7,400	7,400	6,000	5,800	6,200	5,400	5,200	5,200	4,400	4,600	4,600
135	9,000	8,600	8,000	7,200	7,400	7,200	5,800	5,800	6,200	5,200	5,000	5,000	4,200	4,200	4,400
140	8,600	8,200	8,000	7,200	7,000	7,000	5,800	5,800	6,000	5,000	4,800	5,000	4,000	4,000	4,200
145	8,400	8,000	7,800	7,000	6,800	6,600	5,800	5,800	5,800	4,800	4,600	4,800	3,600	3,800	4,000
150	8,000	7,800	7,600	6,800	6,600	6,400	5,600	5,600	5,600	4,400	4,600	4,600	3,400	3,600	3,600
155	7,800	7,600	7,400	6,600	6,400	6,200	5,400	5,400	5,200	4,200	4,200	4,400	3,200	3,400	3,400
160	7,600	7,400	7,200	6,200	6,200	6,000	5,200	5,000	5,000	4,000	4,000	4,200	3,000	3,200	3,200
165	7,200	7,000	7,000	6,000	5,800	5,800	5,000	4,800	4,800	3,800	3,800	4,000	2,800	3,000	3,000
170	7,000	6,800	6,800	5,800	5,600	5,600	4,800	4,600	4,600	3,600	3,600	3,800	2,600	2,800	2,800
175	6,600	6,600	6,800	5,600	5,600	5,600	4,600	4,400	4,600	3,400	3,400	3,600	2,400	2,600	2,600
180	6,400	6,400		5,400	5,400	5,400	4,400	4,400	4,400	3,200	3,400	3,400		2,400	2,600
185		6,200		5,200	5,200	5,200	4,200	4,200	4,200	3,000	3,200	3,200			2,400
190		5,800		5,000	5,000	5,000	4,000	4,000	4,000	2,800	3,000	3,000			2,200
195				4,800	4,800		3,800	3,800	3,800	2,600	2,800	2,800			
200				4,600	4,600		3,600	3,600	3,800	2,400	2,600	2,600			
205							3,600	3,600		2,200	2,400	2,600			
210							3,400	3,400			2,200	2,400			
215							3,200	3,200			2,000	2,200			
220								3,000				2,000			

THIS CHART IS ONLY A GUIDE AND SHOULD NOT BE USED TO OPERATE THE CRANE. The individual crane's load chart, operating instructions and other instructional plates must be read and understood prior to operating the crane.



131 ft.  
(40.0 m)



76 - 92 - 108 - 125 - 141 ft.  
(23 - 28 - 33 - 38 - 43 m)



66,100 lbs.  
(30 000 kg)



100%



360°



Pounds

(Feet)	76 FEET			92 FEET			108 FEET			125 FEET			141 FEET		
	0°	15°	30°	0°	15°	30°	0°	15°	30°	0°	15°	30°	0°	15°	30°
20	12,800			11,200											
25	12,800			11,200											
30	12,800			11,200			9,400								
35	12,800			11,200			9,400			7,600			5,600		
40	12,800			11,200			9,400			7,600			5,600		
45	12,800	12,400		11,200			9,400			7,600			5,600		
50	12,800	12,200		11,200	10,800		9,400	9,000		7,600			5,600		
55	12,800	12,000		11,200	10,400		9,400	8,600		7,600	7,200		5,600		
60	12,800	11,600	10,400	11,200	9,800		9,200	8,200		7,600	7,200		5,600	6,000	
65	12,800	11,400	10,200	10,600	9,400		8,800	7,800		7,600	7,200		5,600	6,000	
70	12,200	11,200	10,000	10,000	9,200	8,800	8,400	7,600	7,400	7,600	7,200		5,600	6,000	
75	11,800	10,800	9,800	9,600	8,800	8,600	8,000	7,400	7,200	7,600	7,200		5,600	6,000	
80	11,200	10,600	9,600	9,200	8,600	8,400	7,600	7,000	7,000	7,400	7,000	6,800	5,600	6,000	6,400
85	10,800	10,200	9,400	8,800	8,400	8,200	7,400	6,800	6,800	7,000	6,800	6,600	5,600	6,000	6,400
90	10,600	10,000	9,200	8,600	8,200	8,200	7,200	6,800	6,600	7,000	6,600	6,400	5,600	6,000	6,400
95	10,200	9,800	9,000	8,400	8,000	8,000	6,800	6,600	6,600	6,800	6,600	6,200	5,600	6,000	6,200
100	10,000	9,800	9,000	8,000	7,800	8,000	6,600	6,400	6,400	6,600	6,400	6,000	5,600	6,000	6,000
105	9,800	9,600	8,800	7,800	7,600	7,800	6,600	6,200	6,400	6,400	6,000	5,800	5,600	6,000	6,000
110	9,600	9,400	8,600	7,800	7,600	7,800	6,400	6,200	6,400	6,200	6,000	5,600	5,600	5,800	5,800
115	9,400	9,400	8,600	7,600	7,400	7,800	6,200	6,000	6,200	6,000	5,800	5,400	5,400	5,400	5,600
120	9,400	9,200	8,400	7,400	7,400	7,800	6,200	6,000	6,200	5,800	5,600	5,400	5,000	5,200	5,200
125	9,200	9,000	8,400	7,400	7,400	7,800	6,000	6,000	6,200	5,600	5,400	5,400	4,800	4,800	5,000
130	9,200	8,800	8,200	7,200	7,400	7,400	6,000	5,800	6,200	5,400	5,200	5,200	4,400	4,600	4,600
135	9,000	8,600	8,000	7,200	7,400	7,200	5,800	5,800	6,200	5,200	5,000	5,000	4,200	4,200	4,400
140	8,600	8,200	8,000	7,200	7,000	7,000	5,800	5,800	6,000	5,000	4,800	5,000	4,000	4,000	4,200
145	8,400	8,000	7,800	7,000	6,800	6,600	5,800	5,800	5,800	4,800	4,600	4,800	3,600	3,800	4,000
150	8,000	7,800	7,600	6,800	6,600	6,400	5,600	5,600	5,600	4,400	4,600	4,600	3,400	3,600	3,600
155	7,800	7,600	7,400	6,600	6,400	6,200	5,400	5,400	5,200	4,200	4,200	4,400	3,200	3,400	3,400
160	7,600	7,400	7,200	6,200	6,200	6,000	5,200	5,000	5,000	4,000	4,000	4,200	3,000	3,200	3,200
165	7,000	7,000	7,000	6,000	5,800	5,800	5,000	4,800	4,800	3,800	3,800	4,000	2,800	3,000	3,000
170	6,400	6,800	6,800	5,800	5,600	5,600	4,800	4,600	4,600	3,600	3,600	3,800	2,600	2,800	2,800
175	5,800	6,200	6,600	5,600	5,600	5,600	4,600	4,400	4,600	3,400	3,400	3,600	2,400	2,600	2,600
180	5,200	5,600		5,200	5,400	5,400	4,400	4,400	4,400	3,200	3,400	3,400		2,400	2,600
185		5,000		4,800	5,200	5,200	4,200	4,200	4,200	3,000	3,200	3,200			2,400
190		4,200		4,200	4,600	4,800	4,000	4,000	4,000	2,800	3,000	3,000			2,200
195				3,600	4,000		3,600	3,800	3,800	2,600	2,800	2,800			
200				3,200	3,600		3,200	3,600	3,800	2,400	2,600	2,600			
205							2,600	3,200		2,200	2,400	2,600			
210							2,200	2,600			2,200	2,400			
215								2,200			2,000	2,200			
220												2,000			

THIS CHART IS ONLY A GUIDE AND SHOULD NOT BE USED TO OPERATE THE CRANE. The individual crane's load chart, operating instructions and other instructional plates must be read and understood prior to operating the crane.



131 ft.  
(40.0 m)



76 - 92 - 108 - 125 - 141 ft.  
(23 - 28 - 33 - 38 - 43 m)



44,100 lbs.  
(20 000 kg)



100%



360°



Pounds

(Feet)	76 FEET			92 FEET			108 FEET			125 FEET			141 FEET		
	0°	15°	30°	0°	15°	30°	0°	15°	30°	0°	15°	30°	0°	15°	30°
20	12,800			11,200											
25	12,800			11,200											
30	12,800			11,200			9,400								
35	12,800			11,200			9,400			7,600			5,600		
40	12,800			11,200			9,400			7,600			5,600		
45	12,800	12,400		11,200			9,400			7,600			5,600		
50	12,800	12,200		11,200	10,800		9,400	9,000		7,600			5,600		
55	12,800	12,000		11,200	10,400		9,400	8,600		7,600	7,200		5,600		
60	12,800	11,600	10,400	11,200	9,800		9,200	8,200		7,600	7,200		5,600	6,000	
65	12,800	11,400	10,200	10,600	9,400		8,800	7,800		7,600	7,200		5,600	6,000	
70	12,200	11,200	10,000	10,000	9,200	8,800	8,400	7,600	7,400	7,600	7,200		5,600	6,000	
75	11,800	10,800	9,800	9,600	8,800	8,600	8,000	7,400	7,200	7,600	7,200		5,600	6,000	
80	11,200	10,600	9,600	9,200	8,600	8,400	7,600	7,000	7,000	7,400	7,000	6,800	5,600	6,000	6,400
85	10,800	10,200	9,400	8,800	8,400	8,200	7,400	6,800	6,800	7,000	6,800	6,600	5,600	6,000	6,400
90	10,600	10,000	9,200	8,600	8,200	8,200	7,200	6,800	6,600	7,000	6,600	6,400	5,600	6,000	6,400
95	10,200	9,800	9,000	8,400	8,000	8,000	6,800	6,600	6,600	6,800	6,600	6,200	5,600	6,000	6,200
100	10,000	9,800	9,000	8,000	7,800	8,000	6,600	6,400	6,400	6,600	6,400	6,000	5,600	6,000	6,000
105	9,800	9,600	8,800	7,800	7,600	7,800	6,600	6,200	6,400	6,400	6,000	5,800	5,600	6,000	6,000
110	9,600	9,400	8,600	7,800	7,600	7,800	6,400	6,200	6,400	6,200	6,000	5,600	5,600	5,800	5,800
115	9,400	9,400	8,600	7,600	7,400	7,800	6,200	6,000	6,200	6,000	5,800	5,400	5,400	5,400	5,600
120	9,400	9,200	8,400	7,400	7,400	7,800	6,200	6,000	6,200	5,800	5,600	5,400	5,000	5,200	5,200
125	9,200	9,000	8,400	7,400	7,400	7,800	6,000	6,000	6,200	5,600	5,400	5,400	4,800	4,800	5,000
130	9,200	8,800	8,200	7,200	7,400	7,400	6,000	5,800	6,200	5,400	5,200	5,200	4,400	4,600	4,600
135	8,600	8,600	8,000	7,200	7,400	7,200	5,800	5,800	6,200	5,200	5,000	5,000	4,200	4,200	4,400
140	7,600	8,200	8,000	7,200	7,000	7,000	5,800	5,800	6,000	5,000	4,800	5,000	4,000	4,000	4,200
145	6,800	7,800	7,800	7,000	6,800	6,600	5,800	5,800	5,800	4,800	4,600	4,800	3,600	3,800	4,000
150	6,000	7,000	7,600	6,200	6,600	6,400	5,600	5,600	5,600	4,400	4,600	4,600	3,400	3,600	3,600
155	5,400	6,200	6,800	5,400	6,400	6,200	5,400	5,400	5,200	4,200	4,200	4,400	3,200	3,400	3,400
160	4,600	5,400	6,000	4,800	5,800	6,000	4,800	5,000	5,000	4,000	4,000	4,200	3,000	3,200	3,200
165	4,000	4,800	5,200	4,200	5,000	5,600	4,200	4,800	4,800	3,800	3,800	4,000			3,000
170	3,400	4,000	4,400	3,600	4,400	5,000	3,600	4,400	4,600	3,400	3,600	3,800			
175		3,400	3,800	3,000	3,800	4,200	3,000	3,800	4,400		3,400	3,600			
180					3,200	3,600		3,200	3,800		3,200	3,400			
185									3,200			3,200			

THIS CHART IS ONLY A GUIDE AND SHOULD NOT BE USED TO OPERATE THE CRANE. The individual crane's load chart, operating instructions and other instructional plates must be read and understood prior to operating the crane.





161 ft.  
(49.0 m)



76 - 92 - 108 - 125 - 141 ft.  
(23 - 28 - 33 - 38 - 43 m)



99,200 lbs.  
(45 000 kg)



100%



360°



Pounds

(Feet)	76 FEET			92 FEET			108 FEET			125 FEET			141 FEET		
	0°	15°	30°	0°	15°	30°	0°	15°	30°	0°	15°	30°	0°	15°	30°
15															
20															
25	11,400														
30	11,400			9,800			8,000								
35	11,400			9,800			8,000								
40	11,400			9,800			8,000			6,000			4,600		
45	11,400			9,800			8,000			6,000			4,600		
50	11,400	11,400		9,800			8,000			6,000			4,600		
55	11,400	10,800		9,800	9,000		8,000	8,400		6,000			4,600		
60	11,400	10,400		9,800	8,600		8,000	8,200		6,000	6,000		4,600	4,800	
65	11,200	10,000		9,400	8,200		8,000	7,800		6,000	6,000		4,600	4,800	
70	10,600	9,600	9,200	8,800	8,000	7,600	8,000	7,600		6,000	6,000		4,600	4,800	
75	10,200	9,200	9,000	8,400	7,600	7,400	8,000	7,200		5,800	6,000		4,600	4,800	
80	9,800	9,000	8,800	8,000	7,400	7,200	7,600	7,000	6,800	5,800	6,000	6,000	4,600	4,800	5,000
85	9,400	8,800	8,600	7,800	7,200	7,000	7,400	6,800	6,600	5,600	6,000	6,000	4,600	4,800	5,000
90	9,000	8,400	8,400	7,600	7,000	7,000	7,200	6,600	6,400	5,600	6,000	6,000	4,600	4,800	5,000
95	8,800	8,200	8,200	7,200	6,800	6,800	6,800	6,400	6,400	5,600	5,800	5,800	4,600	4,800	5,000
100	8,600	8,200	8,200	7,000	6,600	6,600	6,600	6,200	6,200	5,400	5,600	5,800	4,600	4,800	5,000
105	8,200	8,000	8,000	6,800	6,600	6,600	6,400	6,200	6,000	5,400	5,400	5,600	4,600	4,800	5,000
110	8,000	7,800	8,000	6,600	6,400	6,600	6,200	6,000	6,000	5,200	5,400	5,400	4,600	4,800	5,000
115	8,000	7,800	8,000	6,600	6,400	6,400	6,200	5,800	5,800	5,000	5,400	5,400	4,600	4,800	5,000
120	7,800	7,600	8,000	6,400	6,200	6,400	6,000	5,800	5,800	5,000	5,000	5,400	4,600	4,800	5,000
125	7,600	7,600	8,000	6,200	6,200	6,400	5,800	5,600	5,800	4,800	5,000	5,000	4,600	4,800	5,000
130	7,600	7,600	8,000	6,200	6,000	6,400	5,800	5,600	5,600	4,800	5,000	5,000	4,600	4,800	5,000
135	7,400	7,400	8,000	6,000	6,000	6,400	5,600	5,600	5,600	4,800	4,800	4,800	4,600	4,600	4,600
140	7,400	7,400	8,000	6,000	6,000	6,400	5,600	5,400	5,600	4,600	4,800	4,800	4,400	4,400	4,400
145	7,400	7,400	8,000	6,000	6,000	6,400	5,400	5,400	5,600	4,600	4,600	4,800	4,200	4,200	4,200
150	7,400	7,400	8,000	6,000	6,000	6,400	5,400	5,400	5,600	4,400	4,600	4,600	3,800	4,000	4,000
155	7,400	7,400	7,800	5,800	6,000	6,400	5,400	5,400	5,600	4,400	4,400	4,600	3,600	3,800	3,800
160	7,400	7,400	7,800	5,800	6,000	6,400	5,200	5,200	5,600	4,400	4,400	4,600	3,400	3,600	3,600
165	7,400	7,400	7,600	5,800	6,000	6,400	5,200	5,200	5,400	4,400	4,400	4,400	3,200	3,400	3,400
170	7,400	7,400	7,400	5,800	6,000	6,200	5,200	5,200	5,200	4,000	4,200	4,200	3,000	3,000	3,200
175	6,800	7,400	7,200	5,800	6,000	6,000	5,200	5,000	5,000	3,800	4,000	4,000	2,800	2,800	3,000
180	6,000	6,800	7,200	5,800	6,000	5,800	5,000	4,800	4,800	3,600	3,600	3,800	2,600	2,600	2,800
185	5,400	6,200	6,600	5,600	5,800	5,800	4,800	4,800	4,800	3,400	3,400	3,600	2,400	2,400	2,600
190	4,800	5,400	6,000	5,000	5,600	5,600	4,600	4,600	4,600	3,200	3,200	3,400	2,200	2,200	2,400
195	4,200	4,800	5,200	4,400	5,200	5,400	4,400	4,400	4,400	3,000	3,000	3,200			
200	3,600	4,200	4,400	3,800	4,400	5,000	3,800	4,200	4,200	2,800	3,000	3,000			
205	3,000	3,600		3,200	3,800	4,200	3,200	4,000	4,200	2,600	2,800	2,800			
210	2,600	3,000		2,800	3,200	3,600	2,600	3,400	3,800	2,400	2,600	2,600			
215	2,000	2,400		2,200	2,800	3,000	2,200	2,800	3,200	2,200	2,400	2,600			
220					2,200			2,400	2,600		2,200	2,400			
225									2,200						

THIS CHART IS ONLY A GUIDE AND SHOULD NOT BE USED TO OPERATE THE CRANE. The individual crane's load chart, operating instructions and other instructional plates must be read and understood prior to operating the crane.



161 ft.  
(49.0 m)



76 - 92 - 108 - 125 - 141 ft.  
(23 - 28 - 33 - 38 - 43 m)



66,100 lbs.  
(30 000 kg)



100%



360°



Pounds

(Feet)	76 FEET			92 FEET			108 FEET			125 FEET			141 FEET		
	0°	15°	30°	0°	15°	30°	0°	15°	30°	0°	15°	30°	0°	15°	30°
25	11,400														
30	11,400			9,800			8,000								
35	11,400			9,800			8,000								
40	11,400			9,800			8,000			6,000			4,600		
45	11,400			9,800			8,000			6,000			4,600		
50	11,400	11,400		9,800			8,000			6,000			4,600		
55	11,400	10,800		9,800	9,000		8,000	8,400		6,000			4,600		
60	11,400	10,400		9,800	8,600		8,000	8,200		6,000	6,000		4,600	4,800	
65	11,200	10,000		9,400	8,200		8,000	7,800		6,000	6,000		4,600	4,800	
70	10,600	9,600	9,200	8,800	8,000	7,600	8,000	7,600		6,000	6,000		4,600	4,800	
75	10,200	9,200	9,000	8,400	7,600	7,400	8,000	7,200		5,800	6,000		4,600	4,800	
80	9,800	9,000	8,800	8,000	7,400	7,200	7,600	7,000	6,800	5,800	6,000	6,000	4,600	4,800	5,000
85	9,400	8,800	8,600	7,800	7,200	7,000	7,400	6,800	6,600	5,600	6,000	6,000	4,600	4,800	5,000
90	9,000	8,400	8,400	7,600	7,000	7,000	7,200	6,600	6,400	5,600	6,000	6,000	4,600	4,800	5,000
95	8,800	8,200	8,200	7,200	6,800	6,800	6,800	6,400	6,400	5,600	5,800	5,800	4,600	4,800	5,000
100	8,600	8,200	8,200	7,000	6,600	6,600	6,600	6,200	6,200	5,400	5,600	5,800	4,600	4,800	5,000
105	8,200	8,000	8,000	6,800	6,600	6,600	6,400	6,200	6,000	5,400	5,400	5,600	4,600	4,800	5,000
110	8,000	7,800	8,000	6,600	6,400	6,600	6,200	6,000	6,000	5,200	5,400	5,400	4,600	4,800	5,000
115	8,000	7,800	8,000	6,600	6,400	6,400	6,200	5,800	5,800	5,000	5,400	5,400	4,600	4,800	5,000
120	7,800	7,600	8,000	6,400	6,200	6,400	6,000	5,800	5,800	5,000	5,000	5,400	4,600	4,800	5,000
125	7,600	7,600	8,000	6,200	6,200	6,400	5,800	5,600	5,800	4,800	5,000	5,000	4,600	4,800	5,000
130	7,600	7,600	8,000	6,200	6,000	6,400	5,800	5,600	5,600	4,800	5,000	5,000	4,600	4,800	5,000
135	7,400	7,400	8,000	6,000	6,000	6,400	5,600	5,600	5,600	4,800	4,800	4,800	4,600	4,600	4,600
140	7,400	7,400	8,000	6,000	6,000	6,400	5,600	5,400	5,600	4,600	4,800	4,800	4,400	4,400	4,400
145	6,800	7,400	8,000	6,000	6,000	6,400	5,400	5,400	5,600	4,600	4,600	4,800	4,200	4,200	4,200
150	6,000	7,400	8,000	6,000	6,000	6,400	5,400	5,400	5,600	4,400	4,600	4,600	3,800	4,000	4,000
155	5,200	6,400	7,400	5,400	6,000	6,400	5,400	5,400	5,600	4,400	4,400	4,600	3,600	3,800	3,800
160	4,400	5,600	6,600	4,600	6,000	6,400	4,800	5,200	5,600	4,400	4,400	4,600	3,400	3,600	3,600
165	3,800	4,800	5,800	4,000	5,200	6,200	4,000	5,200	5,400	4,000	4,400	4,400	3,200	3,400	3,400
170	3,200	4,200	4,800	3,400	4,400	5,200	3,400	4,600	5,200	3,400	4,200	4,200	3,000	3,000	3,200
175	2,400	3,400	4,200	2,600	3,800	4,600	2,800	3,800	4,800	2,600	3,800	4,000	2,400	2,800	3,000
180	2,000	2,800	3,400	2,200	3,000	3,800	2,200	3,200	4,000	2,000	3,200	3,800		2,600	2,800
185		2,200	2,600		2,400	3,200		2,600	3,400		2,600	3,400		2,400	2,600
190			2,000			2,400		2,000	2,600		2,000	2,800			2,400
195								2,000				2,200			

THIS CHART IS ONLY A GUIDE AND SHOULD NOT BE USED TO OPERATE THE CRANE. The individual crane's load chart, operating instructions and other instructional plates must be read and understood prior to operating the crane.



161 ft.  
(49.0 m)



76 - 92 - 108 - 125 - 141 ft.  
(23 - 28 - 33 - 38 - 43 m)



44,100 lbs.  
(20 000 kg)



100%



360°



Pounds

(Feet)	76 FEET			92 FEET			108 FEET			125 FEET			141 FEET		
	0°	15°	30°	0°	15°	30°	0°	15°	30°	0°	15°	30°	0°	15°	30°
20															
25	11,400														
30	11,400			9,800			8,000								
35	11,400			9,800			8,000								
40	11,400			9,800			8,000			6,000			4,600		
45	11,400			9,800			8,000			6,000			4,600		
50	11,400	11,400		9,800			8,000			6,000			4,600		
55	11,400	10,800		9,800	9,000		8,000	8,400		6,000			4,600		
60	11,400	10,400		9,800	8,600		8,000	8,200		6,000	6,000		4,600	4,800	
65	11,200	10,000		9,400	8,200		8,000	7,800		6,000	6,000		4,600	4,800	
70	10,600	9,600	9,200	8,800	8,000	7,600	8,000	7,600		6,000	6,000		4,600	4,800	
75	10,200	9,200	9,000	8,400	7,600	7,400	8,000	7,200		5,800	6,000		4,600	4,800	
80	9,800	9,000	8,800	8,000	7,400	7,200	7,600	7,000	6,800	5,800	6,000	6,000	4,600	4,800	5,000
85	9,400	8,800	8,600	7,800	7,200	7,000	7,400	6,800	6,600	5,600	6,000	6,000	4,600	4,800	5,000
90	9,000	8,400	8,400	7,600	7,000	7,000	7,200	6,600	6,400	5,600	6,000	6,000	4,600	4,800	5,000
95	8,800	8,200	8,200	7,200	6,800	6,800	6,800	6,400	6,400	5,600	5,800	5,800	4,600	4,800	5,000
100	8,600	8,200	8,200	7,000	6,600	6,600	6,600	6,200	6,200	5,400	5,600	5,800	4,600	4,800	5,000
105	8,200	8,000	8,000	6,800	6,600	6,600	6,400	6,200	6,000	5,400	5,400	5,600	4,600	4,800	5,000
110	8,000	7,800	8,000	6,600	6,400	6,600	6,200	6,000	6,000	5,200	5,400	5,400	4,600	4,800	5,000
115	8,000	7,800	8,000	6,600	6,400	6,400	6,200	5,800	5,800	5,000	5,400	5,400	4,600	4,800	5,000
120	7,800	7,600	8,000	6,400	6,200	6,400	6,000	5,800	5,800	5,000	5,000	5,400	4,600	4,800	5,000
125	7,200	7,600	8,000	6,200	6,200	6,400	5,800	5,600	5,800	4,800	5,000	5,000	4,600	4,800	5,000
130	6,200	7,600	8,000	6,200	6,000	6,400	5,800	5,600	5,600	4,800	5,000	5,000	4,600	4,800	5,000
135	5,200	6,800	8,000	5,400	6,000	6,400	5,400	5,600	5,600	4,800	4,800	4,800	4,600	4,600	4,600
140	4,200	5,800	7,200	4,600	6,000	6,400	4,600	5,400	5,600	4,600	4,800	4,800	4,400	4,400	4,400
145	3,400	5,000	6,200	3,800	5,200	6,400	3,800	5,400	5,600	3,800	4,600	4,800	3,400	4,200	4,200
150		4,000	5,200		4,400	5,600	3,000	4,600	5,600	3,000	4,600	4,600		4,000	4,000
155		3,200	4,200		3,600	4,800		3,800	4,800		3,800	4,600		3,600	3,800
160			3,400			3,800			4,000		3,000	4,200			3,600
165						3,200			3,400			3,400			3,400

THIS CHART IS ONLY A GUIDE AND SHOULD NOT BE USED TO OPERATE THE CRANE. The individual crane's load chart, operating instructions and other instructional plates must be read and understood prior to operating the crane.

# Swingaway & Insert Diagram

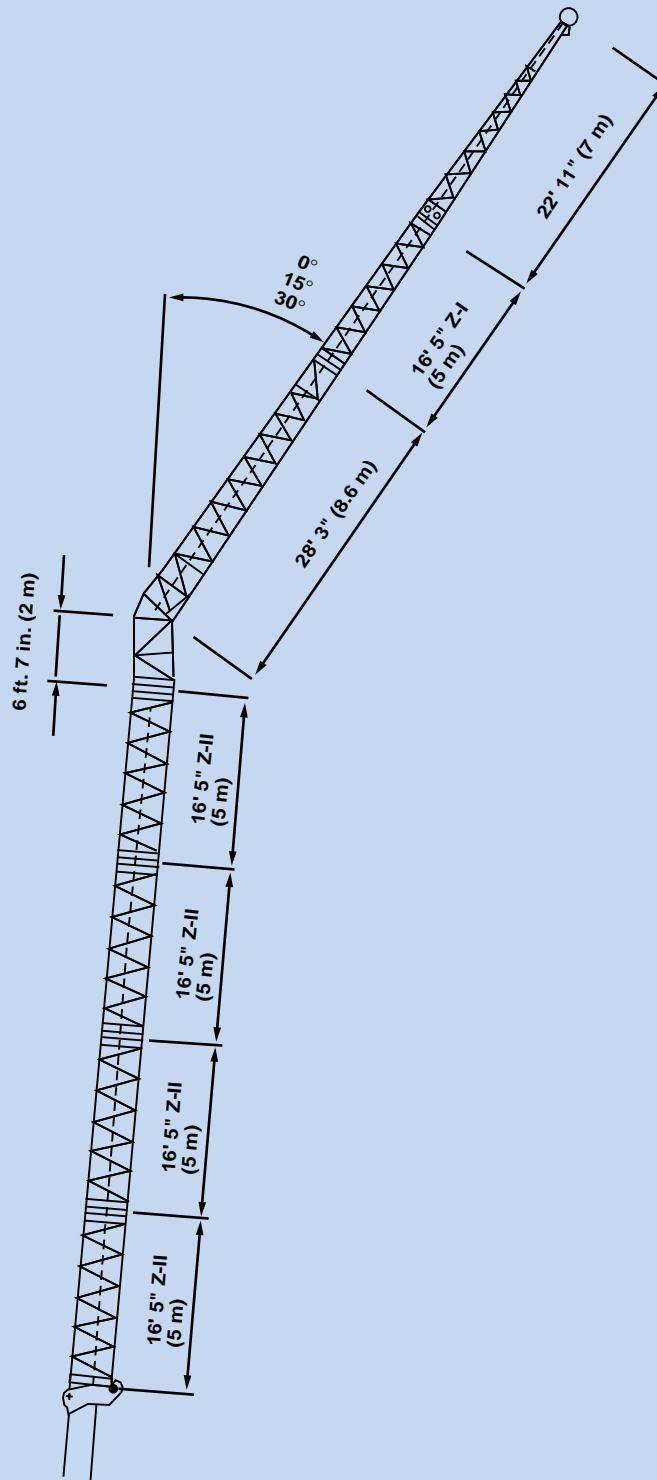

# Rated Lifting Capacities

## Important Notes:

**Warning: THIS CHART IS ONLY A GUIDE.**  
**The notes below are for illustration only and should not be relied upon to operate the crane.**  
**The individual crane's load chart, operating instructions and other instruction plates must be read and understood prior to operating the crane.**





































1. All rated loads have been tested to and meet minimum requirements of SAEJ1063 NOV93 - Cantilevered Boom Crane Structures - Method of Test, and do not exceed 85% of the tipping load on outriggers as determined by SAEJ765 OCT90 Crane Stability Test Code.

2. Capacities given do not include the weight of hook blocks, slings, auxiliary lifting equipment and load handling devices. Their weights must be added to the load to be lifted. When more than minimum required reeving is used, the additional rope weight shall be considered part of the load.

3. All capacities are for crane on firm, level surface. It may be necessary to have structural supports under the outrigger floats to spread the load to a larger bearing surface.

4. For outrigger operation, ALL outriggers shall be properly extended with tires raised free of ground before raising the boom or lifting loads.

# Symbols Glossary

	Frame		Steering
	Outriggers		Transmission
	Outrigger Controls		Axles
	Engine		Brakes
	Fuel Tank Capacity		Tires
	Electrical System		Suspension
	Drive		Rotation
	Lights		Boom Elevation
	Cab		Swing
	Boom		Counterweight
	Fixed Swingaway		Oil
	Tele-Swingaway		Hydraulic System
	Jib		Hoist
	Boom Nose		Radius
	Boom Extension		Boom Length
	Speed		Hookblock
	Grade		Gear
	Lattice Extension		Luffing Jib

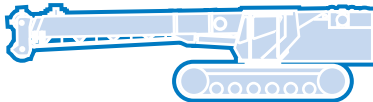
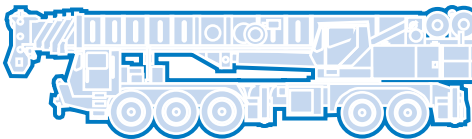
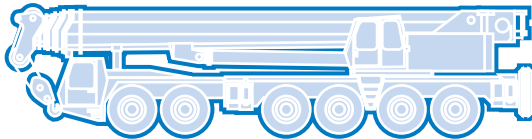
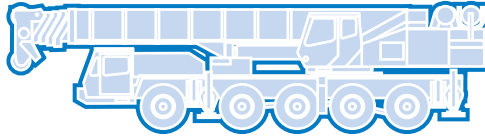
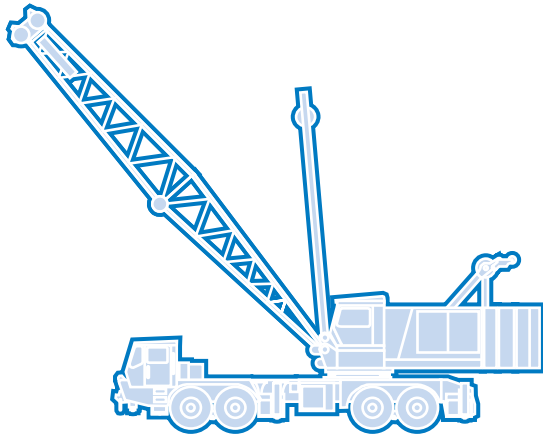

**Grove Worldwide – World Headquarters**

**Grove North America**  
1565 Buchanan Trail East  
P.O. Box 21  
Shady Grove, Pennsylvania 17256, U.S.A.  
Tel: [Int + 1] (717) 597-8121  
Fax: [Int + 1] (717) 597-4062  
Western Hemisphere, Asia/Pacific

**Grove Europe Limited\***  
Sunderland SR4 6TT, England  
Tel: [Int + 44] 191 565-6281  
Fax: [Int + 44] 191 564-0442  
Europe, Africa, Middle East

**Grove Europe Limited\***  
P.O. Box No. 268  
4A Kimber Road  
Abingdon, Oxfordshire, OX141SG  
Tel: [Int + 44] 1235 55-3184  
Fax: [Int + 44] 1235 55-3218  
\*Grove Europe Limited, Registered in England,  
Number 1845128, Registered office, Crown Works,  
Pallion, Sunderland, Tyne & Wear, England SR4 6TT

**Deutsche Grove GmbH  
Sales and Service**  
Helmholtzstrasse 12, Postfach 5026  
D-40750 Langenfeld, Germany  
Tel: [Int + 49] (2173) 8909-0  
Fax: [Int + 49] (2173) 8909-30

**Wilhelmshaven Works**  
Industriegelände West, Postfach 1853  
D-26358 Wilhelmshaven, Germany  
Tel: [Int + 49] (4421) 294-0  
Fax: [Int + 49] (4421) 294-301

**Grove France S.A.**  
16, chaussée Jules-César, 95520 OSNY  
B.P. 203, 95523 CERGY PONTOISE CEDEX  
France  
Tel: [Int + 33] (1) 30313150  
Int: [Int + 33] (1) 30386085

**Grove Asia/Pacific - Regional Office**  
171 Chin Swee Road  
#06-01 San Centre  
Singapore 0316  
Tel: [Int + 65] 536-6112  
Fax: [Int + 65] 536-6119  
Asia/Pacific, Near East

**Grove China - Representative Office**  
Beijing Hotel Room 6074  
No. 33 East Chang An Avenue  
Beijing, 100004, China  
Tel: [Int + 86] (10) 513-7766  
Fax: [Int + 86] (10) 513-7307

**Grove Product Support**  
Western Hemisphere, Asia/Pacific  
1086 Wayne Avenue  
Chambersburg, Pennsylvania USA  
Tel: [Int + 1] (717) 263-5100  
Fax: [Int + 1] (717) 267-0404

Europe, Africa, Middle East  
Sunderland SR4 6TT, England  
Tel: [Int + 44] 191 565-6281  
Parts Fax: [Int + 44] 191 510-9242  
Service Fax: [Int + 44] 191 510-9560

<http://www.grovetworldwide.com>

Constant improvement and engineering progress make it necessary that we reserve the right to make specification, equipment, and price changes without notice. Illustrations shown may include optional equipment and accessories and may not include all standard equipment.

Form No.: GMK5175 Part No.: 3-963 897-10M Printed in U.S.A.



**CUSTOM SERVICE CRANE, INC.**

[www.CustomServiceCrane.com](http://www.CustomServiceCrane.com) | t: 217-897-1700 | [Randy@customservicecrane.com](mailto:Randy@customservicecrane.com)