

## Koenig K 1030 TH Self Erecting Tower Crane

**KOENIG CRANES**  
**North America**

**Bringing Innovation To Construction**

Phone: 877-852-2192 Fax: 604-852-4421  
Email: [info@koenigcranes.com](mailto:info@koenigcranes.com) Internet: [www.koenigcranes.com](http://www.koenigcranes.com)

# K1030 TH Technical Data

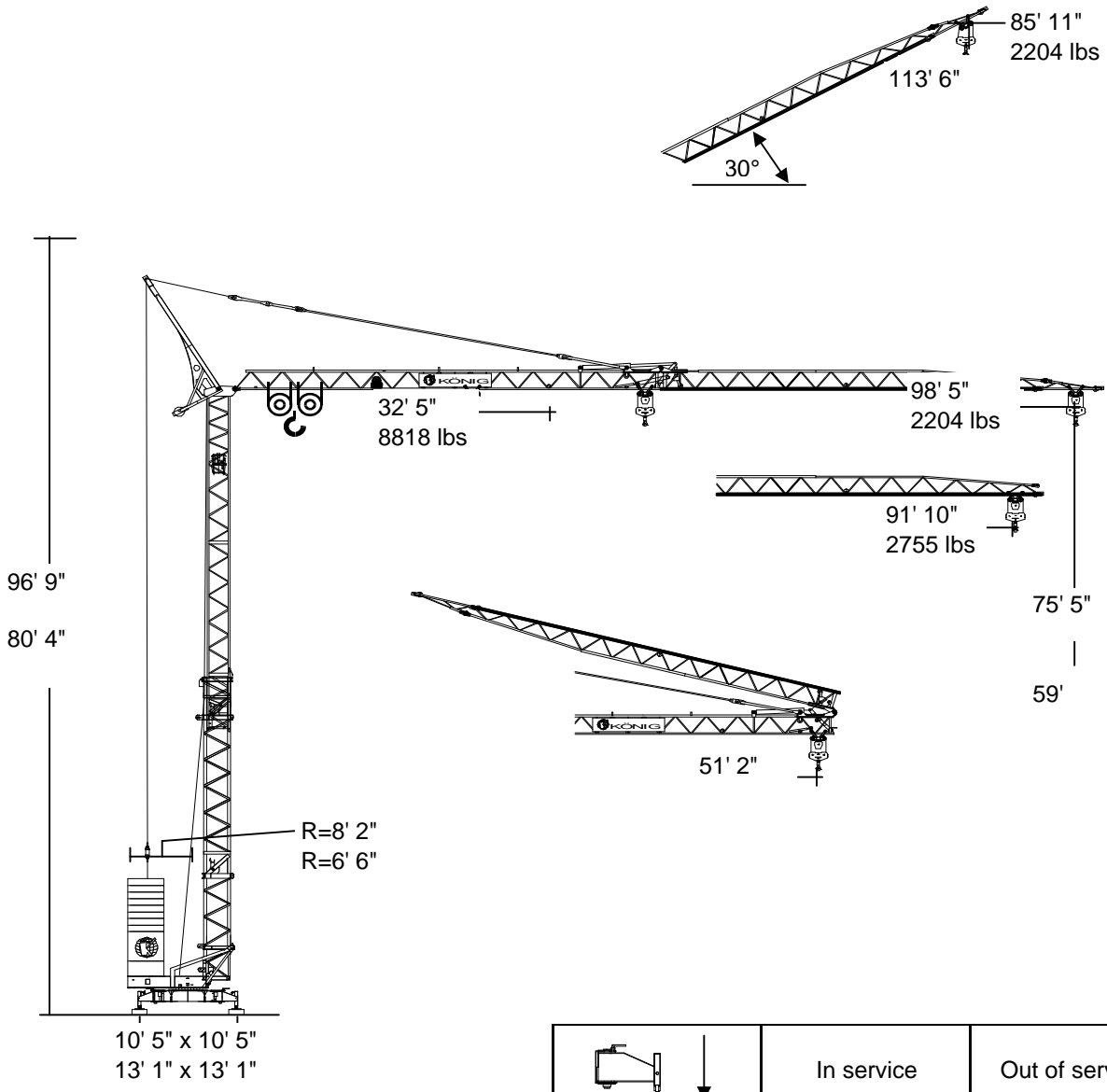



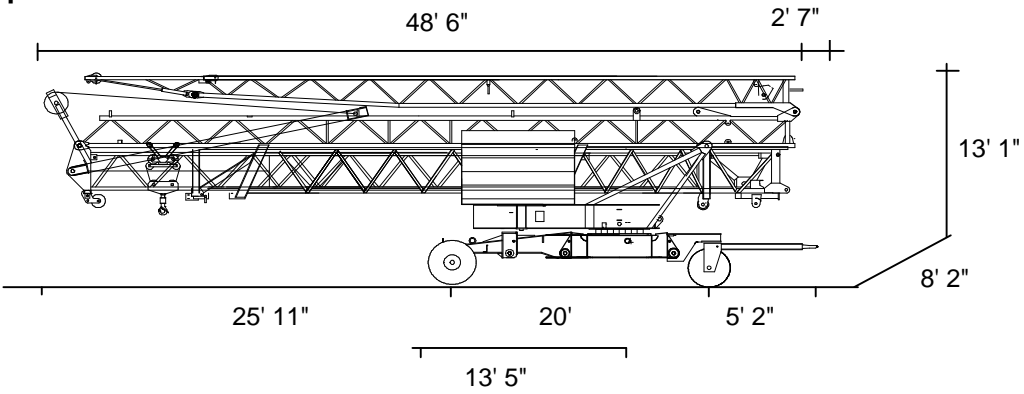

	In service	Out of service
Reactions	22 T	19.5 T





## Transport





# K1030 TH Technical Data

## Radius and capacity

Ausladung		max. Tragkr.		ft x lbs											
ft	0°	T	ft	62	65	68	72	75	78	82	85	88	91	95	98
98		2.2	56.0	4034	3791	3880	3395	3218	3064	2910	2777	2645	2535	2425	2314
91		2.2	63.0	4409	4365	4100	3880	3681	3483	3328	3174	3020	2865		
30°		Ausl. (ft)		<b>55</b>	<b>58</b>	<b>60.0</b>	<b>63.0</b>	<b>66</b>	<b>69.0</b>	<b>72.0</b>	<b>75.0</b>	<b>77.0</b>	<b>80</b>	<b>83</b>	<b>86.0</b>
30°		HH (ft)		95.0	97	98	100	102	103	105	107.0	108	110.0	112	113

Ausladung		max. Tragkr.		ft x lbs											
ft	0°	T	ft	29	33	39	46	52	59	65	72	78	85	92	98
98		2.2	56	4409	4409	4409	4409	4409	4210	3703	3284	2954	2689	2447	2248
		4.4	32	8818	8487	6900	5687	4828	4166	3659	3262	2932	2645	2403	2204
91		2.2	62	4409	4409	4409	4409	4409	4409	4210	3747	3373	3064	2800	
		4.4	35	8818	8818	7804	6437	5467	4739	4166	3703	3328	3020	2755	

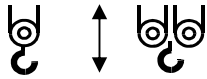
## Speeds

	Step	m/min.	kg	kW
	1	19 - 9	4409 - 8818	3.5
	2	72 - 36	4409 - 8818	9
	3	144 - 39	2425 - 4850	11
	1	20		1.1
	2	40		1.5
	0-0,8	sl./min.		3.0



Cross section of cable up to  
5x10<sup>2</sup>

Operation voltage  
400 V

Frequency  
50 Hz

Power requirement  
13,2 kVA (15,5 KW)

## Weight

Central ballast weight	6.5 T			Transport weight approx.	21.7 T
Counterweight	8' 2"	11 x 1.6 T	18 T	Dead weight approx.	12.8 T
	6' 6"	13 x 1.6 T	31.9 T		

# K1030 TH Technical Data

## Erection

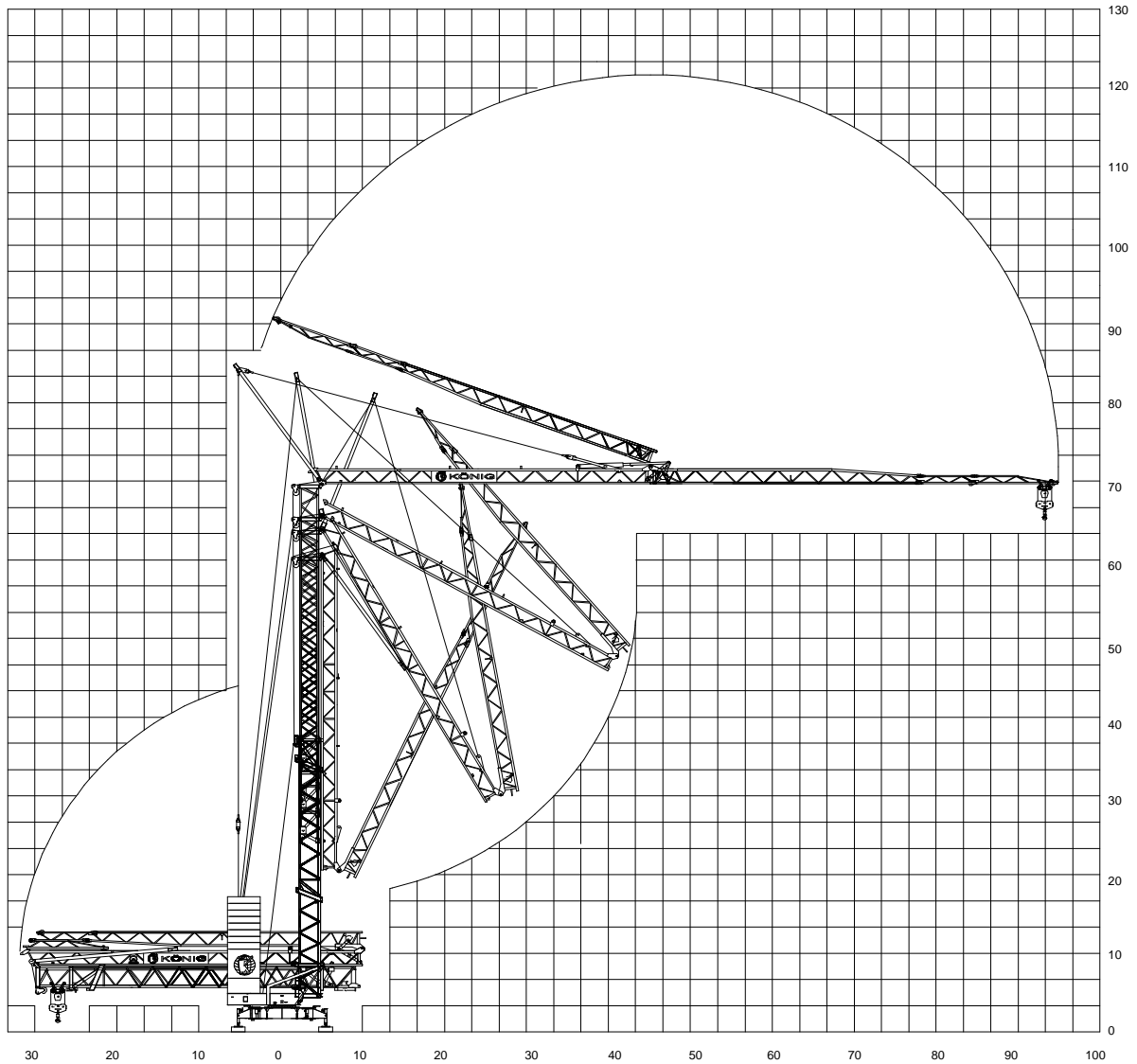

**KOENIG CRANES**  
**North America**

**Bringing Innovation To Construction**

Phone: 877-852-2192 Fax: 604-852-4421  
Email: [info@koenigcranes.com](mailto:info@koenigcranes.com) Internet: [www.koenigcranes.com](http://www.koenigcranes.com)  
All measurements and weights subject to alterations